



## TAY SOFAS

design Massimo Castagna  
2017

The sofa Tay, responds perfectly to the convivial mood that considers the living room to be hub for meeting and socializing. The sofa arrangement consists of four basic units.

Backrest and seat cushions are available in a range of shapes and sizes to allow for maximum freedom of choice and the production of more flexible and versatile combinations: a straight line, a corner formation, with or without backrests, with or without armrests, with lateral chaise-longue extensions, and much more besides. The frame rests on aluminium feet.

The covers are completely removable and a choice of fabric, leather or Ecopelle Dollaro is available. The exceptional comfort of the seat cushions is guaranteed by the internal core of memory-form, making them even more inviting. The sofa arrangement is completed with comfortable backrest and decorative cushions, with completely removable fabric, leather or Ecopelle covers.



LA CULTURA DEL DORMIRE.

COMPOSITION E



- 1 piece - END UNIT A 140 (DX)
- 1 piece - END UNIT A 140 (SX)
- 1 piece - BACKREST CUSHION 110X45
- 1 piece - BACKREST CUSHION 55X45
- 1 piece - BACKREST CUSHION 55X65

TAY SOFAS COMPOSITIONS

OUTER SIZES

SIZE IN CM.

COMPOSITION A

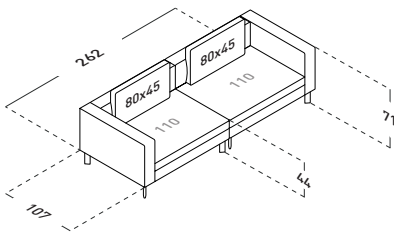

- 1 piece - END UNIT A 110 (DX)
- 1 piece - END UNIT A 110 (SX)
- 2 pieces - BACKREST CUSHIONS 80X45

COMPOSITION B (small table not included)

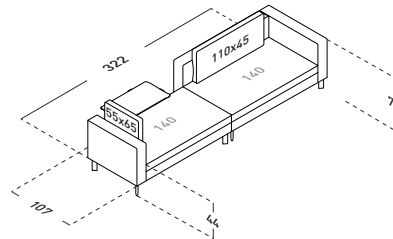

- 1 piece - BASE WITH ARMREST 140
- 1 piece - END UNIT A 140 (DX)
- 1 piece - BACKREST CUSHION 110X45
- 1 piece - BACKREST CUSHION 55X65

COMPOSITION D (small tables not included)

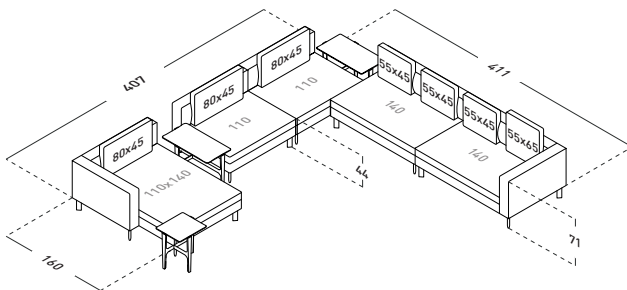

- 1 piece - END UNIT A 110/140 (SX)
- 2 pieces - BASE WITH BACKREST 110
- 1 piece - BASE WITH BACKREST 140
- 1 piece - END UNIT A 140 (DX)
- 3 pieces - BACKREST CUSHIONS 55X45
- 1 piece - BACKREST CUSHION 55X65
- 3 pieces - BACKREST CUSHIONS 80X45

COMPOSITION M (small table not included)

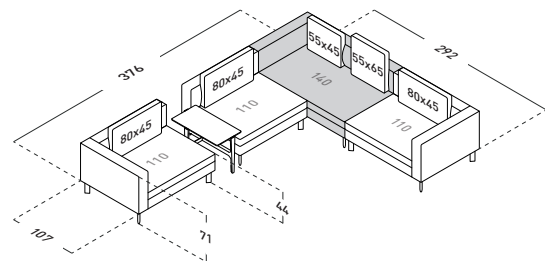

- 1 piece - END UNIT A 110 (SX)
- 1 piece - BASE WITH BACKREST 110
- 1 piece - CORNER UNIT A 140 (SX)
- 1 piece - END UNIT A 110 (DX)
- 3 pieces - BACKREST CUSHIONS 80X45
- 1 piece - BACKREST CUSHION 55X45
- 1 piece - BACKREST CUSHION 55X65

SIZES OF UNIT ELEMENTS

BACKREST

ARMREST

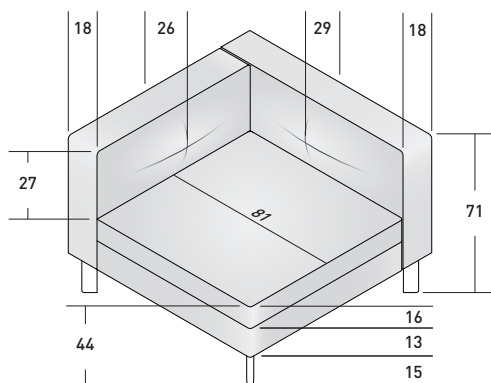

80

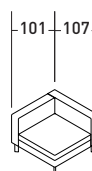

110

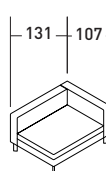

140

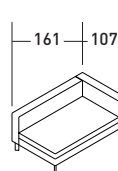

110x140

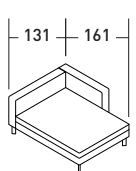

# ELEMENTS TAY SOFAS

OUTER SIZES

SIZE IN CM.

## FREESTANDING UNIT

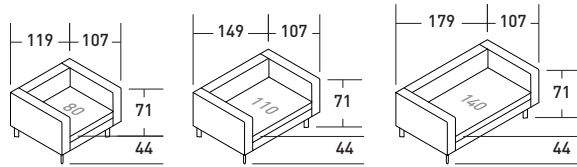

## BASE UNIT

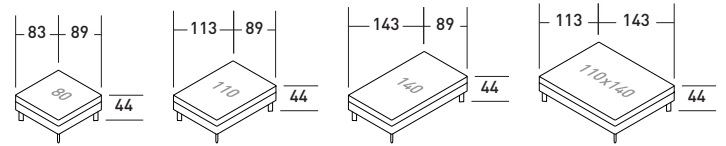

## BASE UNIT WITH BACKREST

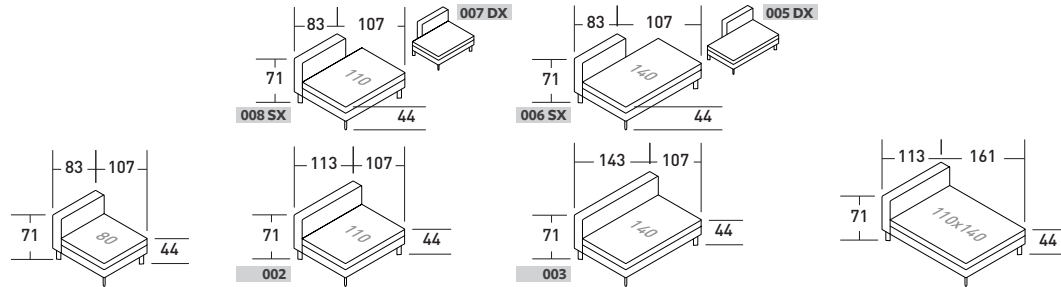

## BASE UNIT WITH ARMREST

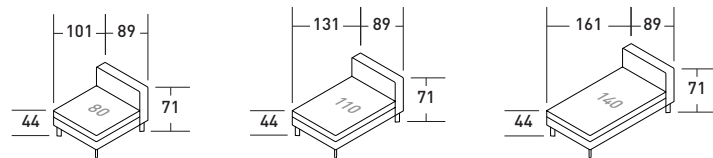

## END UNIT A

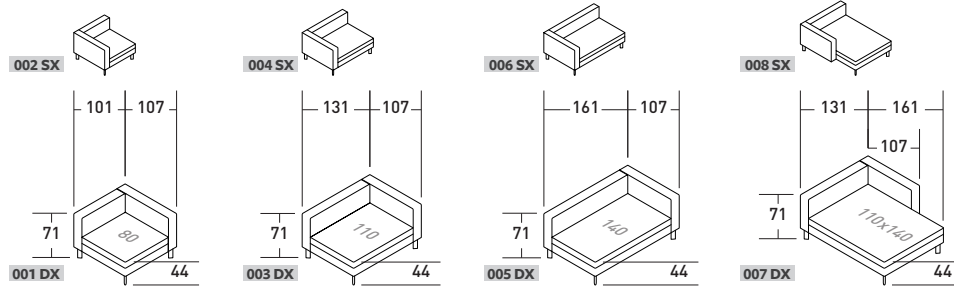

## CORNER UNIT A

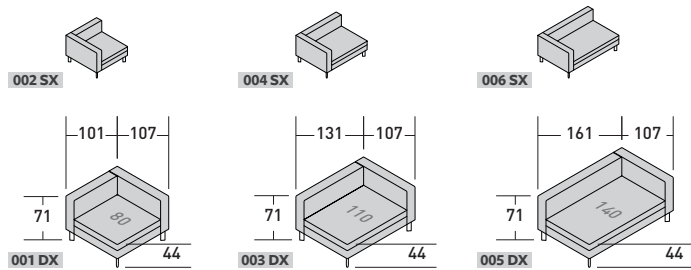

## END UNIT B

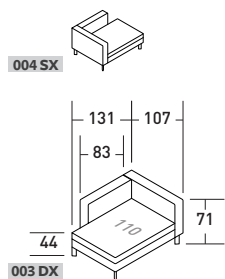

## CORNER UNIT B

